

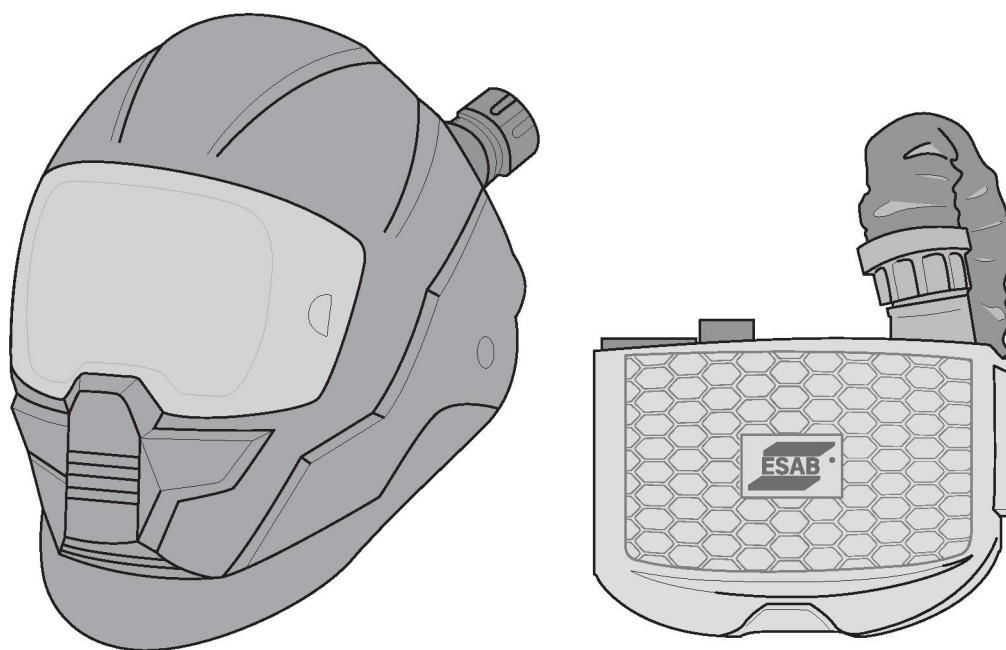

ESAB PAPR System

Respiratory protective device



Instruction manual

ESAB AB

Lindholmsallén 9

Box 8004

402 77 Gothenburg

Sweden

Phone +46 (0) 31 50 90 00

www.esab.com

1	SAFETY	4
1.1	Meaning of symbols	4
1.2	Safety precautions	4
2	INTRODUCTION	6
2.1	Overview	6
2.2	Equipment	6
2.3	Prerequisites	6
3	TECHNICAL DATA	8
3.1	System overview	8
3.2	Technical data	8
3.3	Warranty	9
4	OPERATION	10
4.1	Assembly	10
4.1.1	Belt adjustment	10
4.1.2	Particle filter	11
4.1.3	Removing the filter	11
4.1.4	Inserting a new filter	12
4.1.5	Changing the pre-filter	12
4.1.6	Attaching the hose to the blower unit	12
4.1.7	Donning the welding helmet	12
4.2	Usage	13
4.3	Inspection before use	13
4.3.1	Alarm test	13
4.3.2	Air flow test	14
4.3.3	Batteries	14
4.3.3.1	Charging the battery	14
4.3.3.2	Replacing the battery	15
5	MAINTENANCE	16
5.1	Cleaning	16
5.2	Storage and transportation	16
6	TROUBLESHOOTING	17
	CERTIFIED HELMETS	18
	ORDERING SPARE PARTS	19
	ORDERING NUMBERS AND SPARE PARTS LIST	20
	ESAB PAPR System	20
	Sentinel A50 Air	21
	Warrior Tech Air	21
	F20 and F20 Air	22
	G30 and G30 Air	23
	G40, G50, G40 Air and G50 Air	24

1 SAFETY

1.1 Meaning of symbols

As used throughout this manual: Means Attention! Be Alert!



DANGER!

Means immediate hazards which, if not avoided, will result in immediate, serious personal injury or loss of life.



WARNING!

Means potential hazards which could result in personal injury or loss of life.



CAUTION!

Means hazards which could result in minor personal injury.



WARNING!

Before use, read and understand the instruction manual and follow all labels, employer's safety practices and Safety Data Sheets (SDSs).



1.2 Safety precautions



WARNING!

Failing to follow these instructions may result in risk of fire, electric shock or personal injury.

- Only charge the correct type of rechargeable battery to reduce the risk of explosion, personal injury or other damages.
- Do not open the charger. Any repairs should be done by the manufacturer or authorized service personnel.
- Do not attempt to take the unit apart, this action voids the warranty. Do not disassemble the unit when it is plugged into the mains electric supply to avoid the risk of electric shock or fire.
- Do not use the charger if it is visibly damaged.

Users of ESAB equipment have the ultimate responsibility for ensuring that anyone who works on or near the equipment observes all the relevant safety precautions. Safety precautions must meet the requirements that apply to this type of equipment. The following recommendations should be observed in addition to the standard regulations that apply to the workplace.

All work must be carried out by trained personnel well-acquainted with the operation of the equipment. Incorrect operation of the equipment may lead to hazardous situations which can result in injury to the operator and damage to the equipment.

1. Anyone who uses the equipment must be familiar with:
 - its operation
 - location of emergency stops
 - its function
 - relevant safety precautions
 - welding and cutting or other applicable operation of the equipment
2. The operator must ensure that:
 - no unauthorised person is stationed within the working area of the equipment when it is started up
 - no-one is unprotected when the arc is struck or work is started with the equipment
3. The workplace must:
 - be suitable for the purpose
 - be free from drafts
4. Personal safety equipment:
 - Always wear recommended personal safety equipment, such as safety glasses, flame-proof clothing, safety gloves
 - Do not wear loose-fitting items, such as scarves, bracelets, rings, etc., which could become trapped or cause burns
5. General precautions:
 - Make sure the return cable is connected securely
 - Work on high voltage equipment **may only be carried out by a qualified electrician**
 - Appropriate fire extinguishing equipment must be clearly marked and close at hand
 - Lubrication and maintenance must **not** be carried out on the equipment during operation



NOTE!

Dispose of electronic equipment at the recycling facility!

In observance of European Directive 2012/19/EC on Waste Electrical and Electronic Equipment and its implementation in accordance with national law, electrical and/or electronic equipment that has reached the end of its life must be disposed of at a recycling facility.

As the person responsible for the equipment, it is your responsibility to obtain information on approved collection stations.

For further information contact the nearest ESAB dealer.

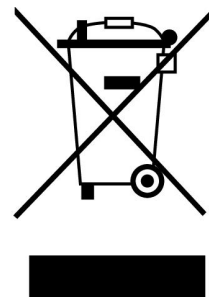

ESAB has an assortment of welding accessories and personal protection equipment for purchase. For ordering information contact your local ESAB dealer or visit us on our website.

2 INTRODUCTION

These user instructions must be followed when using and operating the ESAB PAPR System. Failure to follow these instructions may void the warranty of the product(s). Refer to the terms of your purchase contract in respect of the product(s) for the specific details of the warranty.

2.1 Overview

The ESAB PAPR System is a respiratory protective system that circulates over-pressured air in the hood. The belt-mounted blower unit delivers air through a filter and via an air hose into the headpiece. The supply of filtered air creates positive pressure inside of the headpiece, which prevents the external contaminated air from entering the breathing zone.

2.2 Equipment

The ESAB PAPR System is supplied with:

- Blower unit including battery, P R SL particle filter and pre-filter
- Belt
- Air hose
- Air flow indicator
- Battery charger
- Instructions manual

2.3 Prerequisites

Use the ESAB PAPR System during welding in unconfined spaces, strictly in accordance with this Instruction manual and the instructions supplied with the corresponding helmets.

Do not use the unit:

- When the blower unit is switched off. When the blower unit is switched off, little or no respiratory protection is to be expected. Rapid buildup of carbon dioxide and depletion of oxygen may occur in the head unit.
- In an atmosphere that poses an immediate health or hygiene hazard and/or has less than 19.5% oxygen content, or contains unknown substances.
- In confined spaces or unventilated areas such as tanks, pipes and canals.
- Near flames and/or sparks.
- In areas with danger of explosion.
- In areas with high winds.
- If the blower unit malfunctions.

Make sure moving parts are not blocked in their movement.

Do not modify or alter the unit or the particle filter in any way.

Protect the unit from ingress of water or other liquids, in particular the motor and fan, the filter and the battery.

Make sure that the headpiece fits perfectly. The efficiency of the system is only sufficient in this case. The protective factor of the complete system is reduced if the seal of the headpiece is not fitted properly, for example if long hair or facial hair is extending into the seal line.

Correct respiratory protection will not be provided if any part of the equipment is modified in any way.

Position the blower unit in a way that minimises the risk of the head unit hose becoming caught up during use. Filters must be attached to the blower unit, and not directly to the headpiece.

During elevated inhalation flow the pressure in the device may become negative.

Leave the contaminated area immediately and if needed seek medical advice if:

- The Manufacturer's Minimum Design Flow (MMDF) warning alarm sounds.
- Breathing becomes difficult.
- Dizziness or distress occurs.
- Any part of the system becomes damaged.
- Airflow into the head unit decreases or stops.
- Contaminant can be smelt or tasted inside the head unit.
- In the unlikely event of an allergic reaction to the material of the headpiece.

3 TECHNICAL DATA

3.1 System overview

The ESAB PAPR System is a belt mounted powered respirator with a replaceable, disposable high efficiency particle filter. The system is certified with the helmets covered in the “Certified helmets” section.

The unit has a removable and rechargeable Lithium-ion battery. Battery life varies depending on the air quality and particle concentration of the work area.

The unit has visual alarm for indicating low battery and a multifunctional alarm for indicating filter blockage. Do not use the unit when it alarms.

The particle filter is designed for the unit. Check the particle filter for any damage or deformation that could lead to contaminated air getting into the unit. In a dusty environment the filter needs to be replaced frequently. The particle filter must be disposed if it is damaged or clogged, and is triggering the alarm.

The unit warns with an audible alarm and flashing LEDs if the MMDF of 170 l/min is not achieved. Leave the contaminated area immediately if the warning alarm sounds.

3.2 Technical data

Air flow	
General	180–220 l/min
Minimum	170 l/min
Weight with particle filter	870 g (1.9 lb)
Operating temperature	0–40 °C (32–104 °F)
Operating time	
Minimum flow rate, fully charged battery, clean environment	> 8 hours
Maximum flow rate	6 hours
Type of particle filter	P R SL
Battery	
Type	Replaceable and rechargeable Li-ion 7.4 V 5200 mAh
Charging cycles	> 350
Alarms	
Low battery	Visual alarm
Insufficient flow rate (below 170 L/min)	Visual, audible, vibration alarms
Actual Protection Factor (APF)	20/50
Noise level	65 dBA

Symbols

Refer to the manufacturer's Instruction Manual



Store between 0-40 °C (32-104 °F)



Best before YYYY/MM



Maximum storage humidity < 75%



Filter symbols:

R = The filter is reusable for more than one shift.

S = The filter protects against solid particles.

L = The filter protects against liquid particles.

3.3 Warranty

ESAB verifies that each product is free from defects of material and workmanship at the time of delivery and is functioning according to its intended use.

ESAB provides warranty on defects of material and workmanship according to legal requirements. Consumables are exempt from this warranty.

ESAB provides warranty on the ESAB Blower unit for a period of 12 months from the date of purchase against mechanical or electrical defects.

ESAB provides warranty on the ESAB battery for a period of 12 months from the date of manufacture.

The warranty does not cover any damages or functional deficiencies resulting from

- overloading, abusing or non-intended use of the product
- collisions or accidents
- non compliance with indications stated in these operating instructions
- improper installation or assembly
- insufficient maintenance
- modifying the product from its original state
- chemical influences
- normal wear and tear during proper operation

ESAB assumes no liability other than for replacement or repair of faulty parts.



NOTE!

In the event of a claim, contact the retailer from which the unit was purchased.

4 OPERATION

4.1 Assembly

Attach the respiratory unit onto the belt. Pass the strap through loops and the buckle.

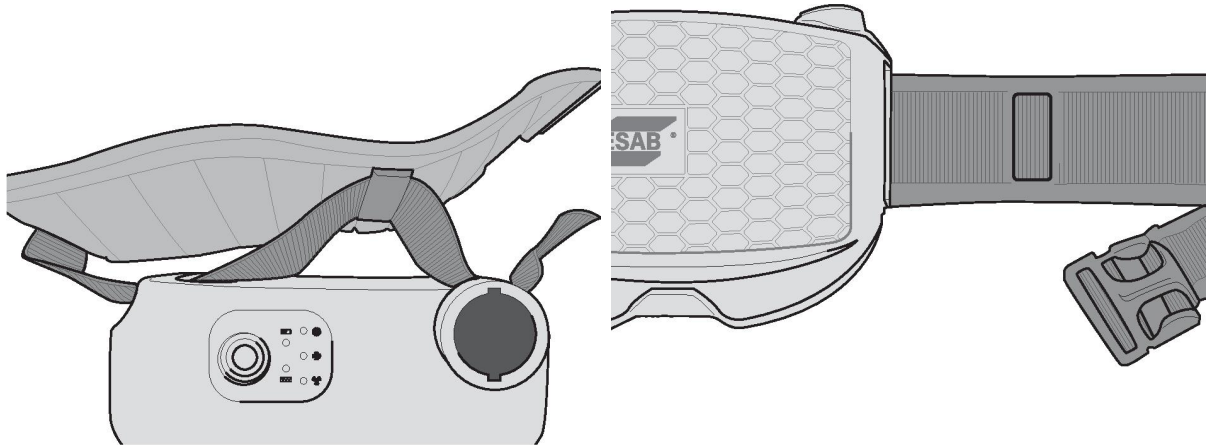

Fit the battery to the blower unit:

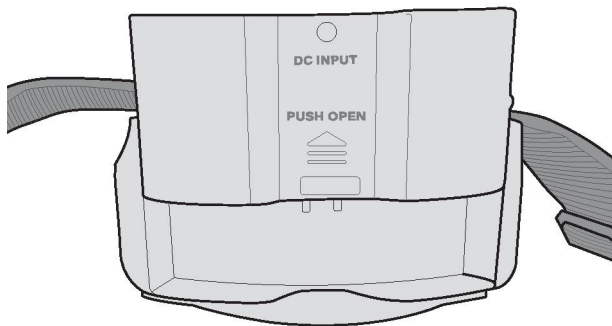

Make sure that the battery is the indicated way up.

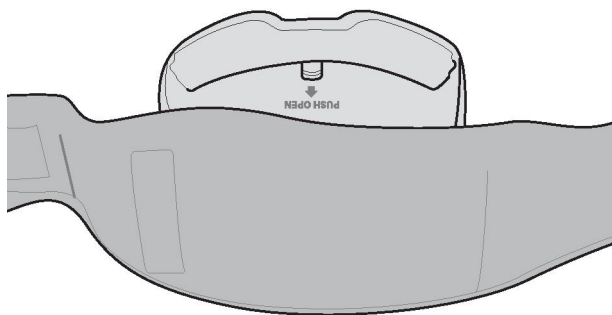

Make sure that the battery is snapped into position.

4.1.1 Belt adjustment

Fasten the belt using the adjusters to achieve a comfortable and secure fit. Secure any excess belt.

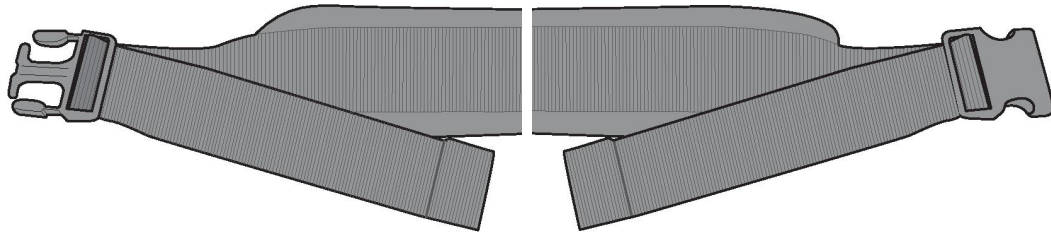
*Loosen**Tighten*

4.1.2 Particle filter

Use only particle filters supplied by ESAB.



WARNING!

Using any other filter voids the warranty and/or poses a serious risk to the health of the operator.

Make sure to use correct kind of filter to achieve suitable protection from the hazard. The respiratory power unit is equipped with a high efficiency particle filter of class P R SL.

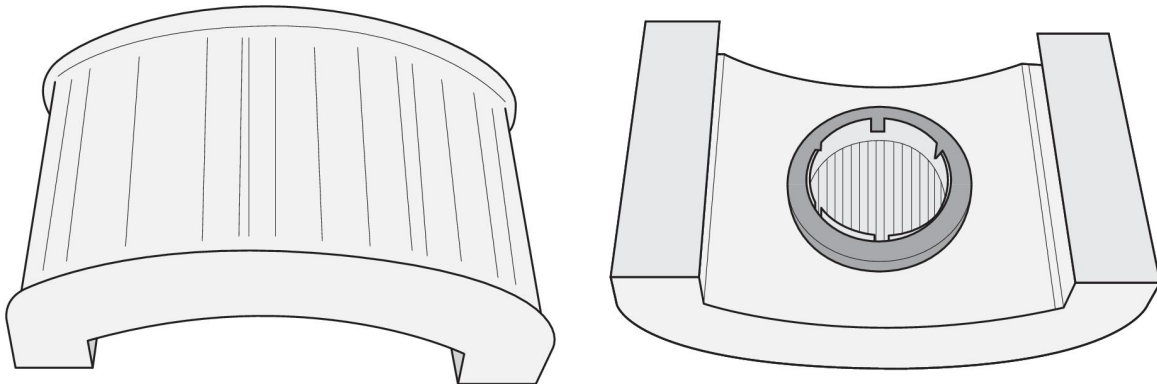

At warning alarm, replace or check the pre-filter. In very dusty areas this is necessary on a frequent basis.

Check and replace the filters regularly, see "Air flow test" section. Do not try to clean and reuse filter.

Make sure the new filter is within the expiry date, unused and not damaged. The maximum lifecycle of a filter is 2 weeks or 90 hours, whichever is reached first. Do not exceed the timeframe.

4.1.3 Removing the filter

Pull up the cover from the right side of the blower to open the filter cover.



NOTE!

Do not use any tools to open the filter cover.

To remove the filter, pull it out of the unit. Clean the unit from dust ensuring no dust enters the air inlet.

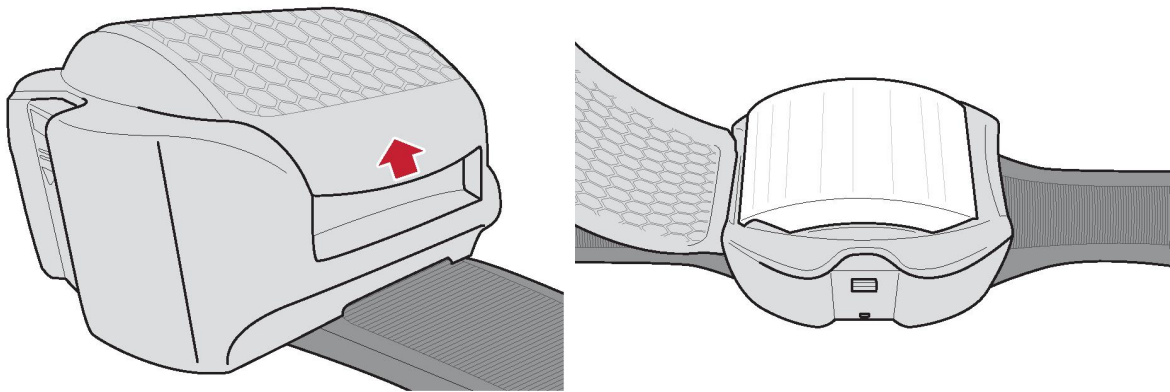

4.1.4 Inserting a new filter

To insert a new filter, put the filter back into position. Gently push until it fits well.

Snap the cover properly into the blower to close the filter cover. Do not use the blower unit without the cover fitted correctly.

4.1.5 Changing the pre-filter

The pre-filter is a sleeve, fitted over the main filter. To remove or replace simply pull off the old filter and stretch the new one into position. Make sure that the main filter is completely covered by the pre-filter.

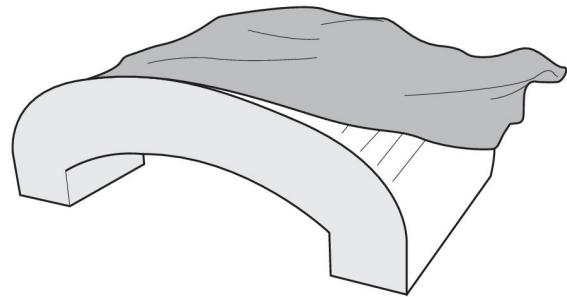

4.1.6 Attaching the hose to the blower unit

Align the pins of the hose bayonet connector with the slots in the air outlet of the blower. Push the bayonet connector into the blower until it reaches the bottom of the hole and then twist it clockwise until the locating pins clip into place.

Fit the hose to the hoods using the same method.

4.1.7 Donning the welding helmet

Set the rake of the welding helmet. Adjust the welding filter to suit, see the helmet Instruction manual.

Lift the helmet to its upper position.

Place over the head. Adjust the headgear ratchet wheel by pushing it in and twisting until a satisfactory tightness is achieved.

Pull the elasticated chin guard downwards and at the same time pull the helmet down. Ensure the elasticated chin guard fits comfortably under the chin.

The welding helmet is now ready for use.



4.2 Usage

Switch on the unit by pressing the **ON/OFF** button on the control panel. The airflow can be adjusted by pressing the **+ / -** buttons from 180 l/min up to 220 l/min in six speeds.

The green LED diodes show the actual airflow level.

To prevent accidental changes, press and hold the buttons for 2 seconds for the action to occur.

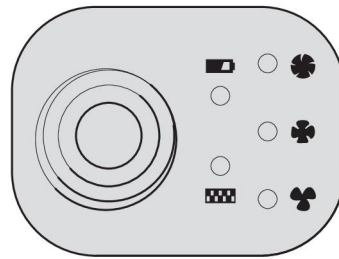

The unit ensures constant supply of air. The microprocessor regulates the motor speed. If the microprocessor cannot keep the adjusted airflow, a beeping alarm sounds. Check the blower unit at this point. If possible, the microprocessor will reduce the airflow to the next lower level. If it fails, the alarm continues to sound. When the airflow falls below the minimum safe operating level, a second audible alarm joins the first. Leave the working environment and reach a safe area to change the filter, or recharge or replace the battery.

Normal function is achieved with a fully charged battery.

At startup, the battery LED will flash red on the control panel. If the LED stays red the battery level is low and must be charged.

If the problem persists, see "Troubleshooting" section.

4.3 Inspection before use

- Check that all components are in good condition with no visible damage. Check the air hose, seals and the face piece. Replace any damaged or worn out parts.
- Make sure there is a good connection between the air hose, the headpiece and the blower unit.
- Check that there is sufficient air flow, see "Air flow test" section.
- Check that the air is supplied through the whole respiratory system from the blower to the hood.
- Check that the battery has sufficient charge, see "Batteries" section.
- Ensure the alarms are working correctly, see "Alarm test" section.

4.3.1 Alarm test

Block the air outlet with the palm of a hand or other suitable means.

The motor will try to compensate by increasing the speed until the alarm sounds.

4.3.2 Air flow test

1. Disconnect the air hose from the blower unit.
2. Insert the airflow indicator into the air hose connector and keep the hose in vertical position at about eye level.
3. Switch the power unit on. The airflow is sufficient only if the ball indicator reaches the minimum flow rate level. If the indicator is below the minimum flow rate level, recharge or replace the battery or change the filter. If the problem persists, see "Troubleshooting" section.

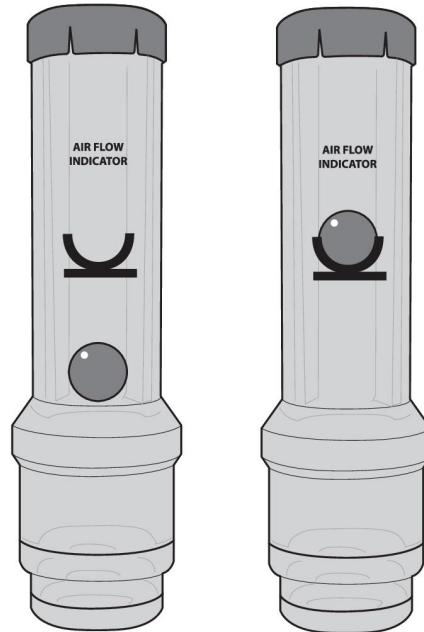

4.3.3 Batteries



WARNING!

Use only ESAB original battery charger delivered with the product. Using any other battery charger voids the warranty and poses a serious risk of fire or explosion to the health of the operator.



NOTE!

Batteries are delivered partially charged. All batteries must be fully charged before first use. The battery can be charged separately or in the blower unit.

Do not use the charger for any other purpose than for which it was manufactured.

Do not charge the battery in a potentially explosive atmosphere.

The battery charger is intended for indoor use and it must be protected from moisture.

The battery charger controls the charging automatically. When the battery has been charged, the charger switches to the trickle charging regime and keeps the battery fully charged. The charging time is 4 to 6 hours.

4.3.3.1 Charging the battery

1. Check that the voltage of the electrical power supply is correct.
2. Plug the charger into the socket, either direct into the blower when the battery is fitted or into the battery directly.
3. Connect the battery to the charger. The socket of the battery is positioned on the back side. The charging state is indicated by a red LED.
4. After charging has been completed, the trickle charging regime is activated. The red LED goes out and the green LED illuminates during trickle charging.
5. Disconnect the charger from the power supply. **Do not leave the battery charger in the power supply if not in use!**

4.3.3.2 Replacing the battery

Remove the battery

Locate the battery catch. Pull back the battery catch and remove the battery by lifting it upwards.

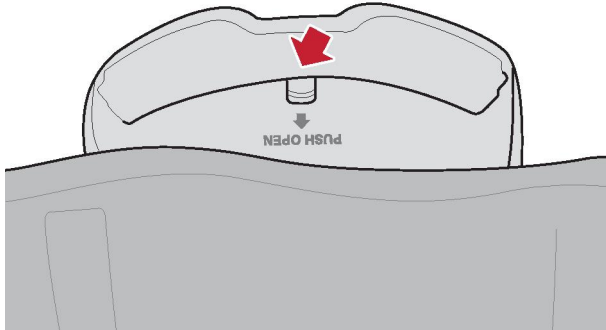

Insert the battery

Make sure the battery is facing the correct direction, see "Assembly" section. Slide it into the blower until the battery catch engages.

Make sure that the battery catch is fully locked.

5 MAINTENANCE

5.1 Cleaning

Clean the blower unit, filter housing and head unit regularly.

For single users, the units can be cleaned with a cloth moistened with lukewarm water and soap.

For multiple users, disinfect when passed from one user to another.

Do not allow liquid to enter the workings of the blower unit or get on to the element of the filter.

Allow the parts to air dry. Do not use solvents or abrasive cleaning agents. Do not dry the unit using hot air or radiant heat.

The unit provides protection to the designed specification for 2 to 3 years, when maintained in accordance with these instructions. Prior to each use check that the unit is free from defects as cracks, split filters and hoses, cracked visors and helmet components.

5.2 Storage and transportation

Store or transport the blower and head units in the container in which they were provided, or in similar container.

Protect it from direct sunlight, solvents and physical damage.

Store between 0-40 °C and below 75% RH.

6 TROUBLESHOOTING

If there is a sudden change in air supply while using the system, check:

- the battery and its connector.
- that all parts of the air-supply system are assembled properly.
- that the charger is not faulty or malfunctioning (diodes off).
- if the filters are clogged and need to be replaced.
- that there is no hole in the air hose.
- that the hood seal is not damaged.
- that the working time after a full recharge of the battery has not decreased (if so, replace the battery).

Fault	Probable reason	Recommendation
The blower unit does not work at all.	Entirely depleted battery: Check if the blower unit works with another charged battery.	Charge the battery. If the problem persists, check the battery.
	Faulty motor, circuit board or connector.	Contact supplier.
Low airflow.	Blocked air hose or airduct.	Remove possible blockage.
	Leakage.	Check seals, connectors and air hose. Make sure that air cannot leak through holes or tears.
	Battery is not charged enough.	Charge the battery. If the problem persists, check the battery.
	Blocked filter or pre-filter.	Change the pre-filter. If the problem persists change the main filter.
Short operating time.	Clogged filter.	Change filter.
	Battery is not charged properly.	Charge the battery. If the problem persists, check the battery.
Battery cannot be charged.	Battery contact is damaged.	Check the battery contact.
	Charger is faulty.	Contact supplier.
Battery cannot be charged sufficiently.	Battery is worn out.	Install a new battery.

CERTIFIED HELMETS

Helmets certified together with the PAPR system:

A20
A30
SENTINEL A50™
Warrior™ Tech
F20
G30
G40
G50

ORDERING SPARE PARTS



CAUTION!

Repair and electrical work should be performed by an authorised ESAB service technician. Use only ESAB original spare and wear parts.

The ESAB PAPR System is designed and manufactured in accordance with the international and European standard **EN12941:1998+A1:2003+A2:2008** as a **TH2 / + P R SL** device offering an Assigned Protection Factor of 20 / 50 according to BS4275. Certified by APAVE SUDEUROPE SAS Notified Body 0082. The ESAB PAPR System can provide this level of protection when used with filters provided by the manufacturer marked **ESAB** and **EN12941:1998 TH2/3P R SL**. Welding helmets are certified to **EN 175B**. This PPE device complies with the following applicable EU standards: **EN166B:2001 EN379:2003 + A1:2009 EN175B**. The ESAB PAPR System is manufactured under **ISO 9001:2000 Quality System**. On completion of service or repair work, it is the responsibility of the person(s) performing the work to ensure that the product still complies with the requirements of the above standards.

Spare parts and wear parts can be ordered through your nearest ESAB dealer, see esab.com. When ordering, please state product type, serial number, designation and spare part number in accordance with the spare parts list. This facilitates dispatch and ensures correct delivery.

ORDERING NUMBERS AND SPARE PARTS LIST

ESAB PAPR System

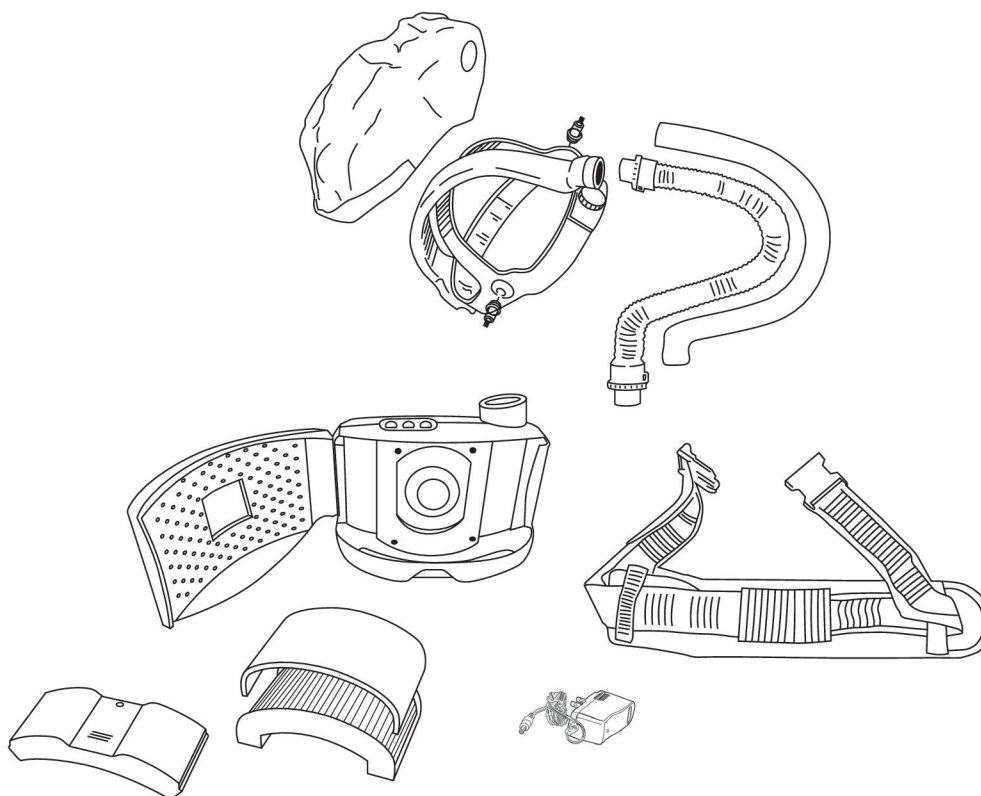

Item	Ordering no.	Denomination	Notes
	0700 002 303	Proban hose cover	1000 mm
	0700 002 304	Proban hose cover	850 mm
	0700 002 305	Air hose standard	850 mm
	0700 002 306	Air hose long	1000 mm
	0700 002 314	Flexi hose	
	0700 002 307	Comfort belt	
	0700 002 308	Motor unit	
	0700 002 309	P3 filter	
	0700 002 310	Pre-filter Pk 5	
	0700 002 311	Intelligent charger	
	0700 002 312	Battery	
	0700 002 313	Battery HD	

Sentinel A50 Air

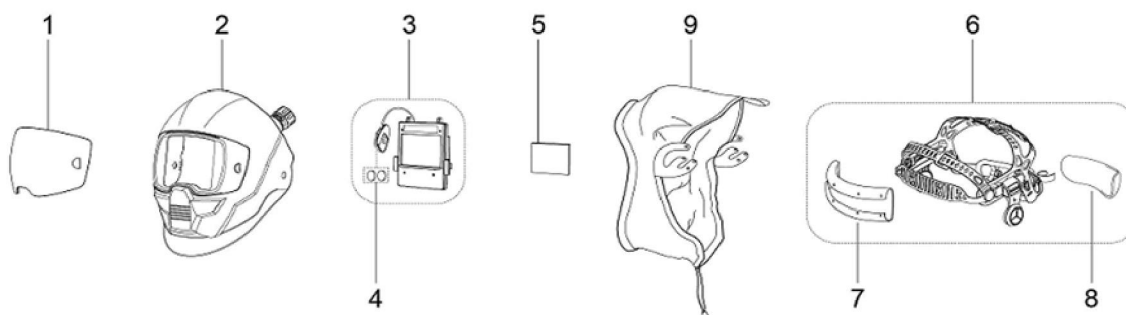

Item	Ordering no.	Denomination	Notes
1	0700 000 802	Front cover lens	Clear
1	0700 000 803	Front cover lens	Amber
2	0700 000 813	Sentinel A50 Air shell with air duct	
3	0700 000 806	Auto-darkening filter	Including 2 × CR2450 lithium battery
4	0700 000 807	2 × CR2450 lithium battery	
5	0700 000 808	Inside cover lens	100 × 64 mm
6	0700 000 805	Headgear for A50 Air	Including sweatbands
7	0700 000 810	Front sweat band	
8	0700 000 812	Rear sweat band	
9	0700 000 814	Face seal for A50 Air	

Warrior Tech Air

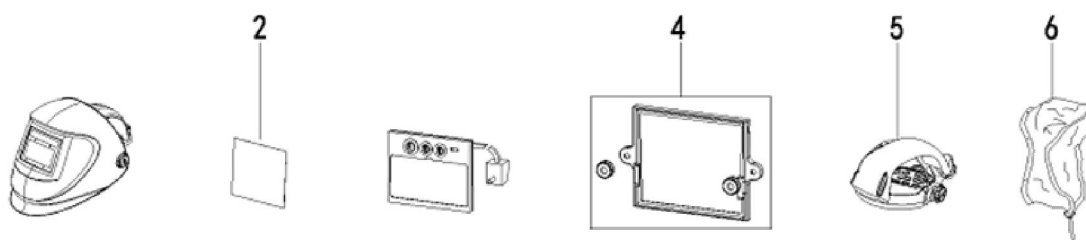

Item	Ordering no.	Denomination	Notes
2	0700 000 010	Front lens	
4	0700 000 419	Warrior lens retainer	
5	0700 000 420	Headgear and airduct	
6	0700 000 421	Warrior face seal	

F20 and F20 Air

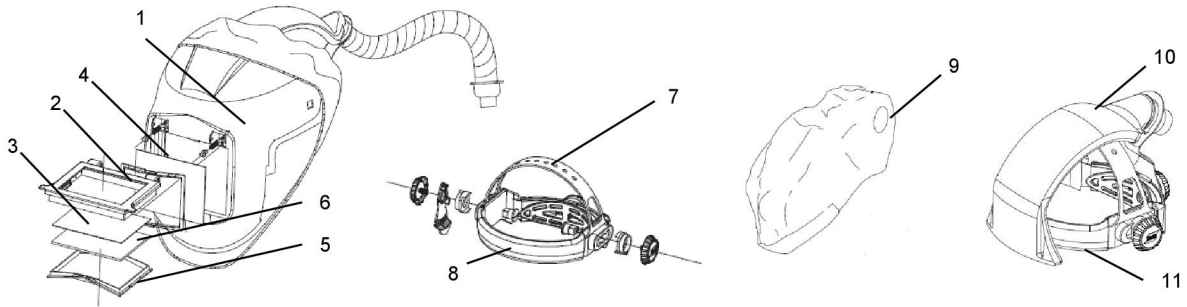

Item	Ordering no.	Denomination	Notes
	0700 000 426	F20, complete	60 × 110 mm
	0700 000 427	F20, complete	90 × 110 mm
	0700 000 428	F20 Air, complete	60 × 110 mm
	0700 000 429	F20 Air, complete	90 × 110 mm
1	0700 000 509	Main shell	F20
2	0700 000 510	Visor flip	F20 60 × 110 mm
2	0700 000 511	Visor flip	F20 90 × 110 mm
3	0160 307 001	Front cover lens	F20 60 × 110 mm
3	0160 307 004	Front cover lens	F20 90 × 110 mm
4	0160 307 004	Inside cover lens	F20 90 × 110 mm and 60 × 110 mm
5	0700 000 256	Lens buckle	90 × 110 mm
5	0700 000 255	Lens buckle	60 × 110 mm
6	0760 031 633	Mineral glass	90 × 110 mm
6	0160 292 003	Mineral glass	60 × 110 mm
7	0700 000 415	Headgear	
8	0700 000 414	Sweatband	
9	0700 000 522	Head and face seal	F20
10	0700 000 420	Headgear including airduct	
11	0700 000 274	Sweatband for air	

G30 and G30 Air

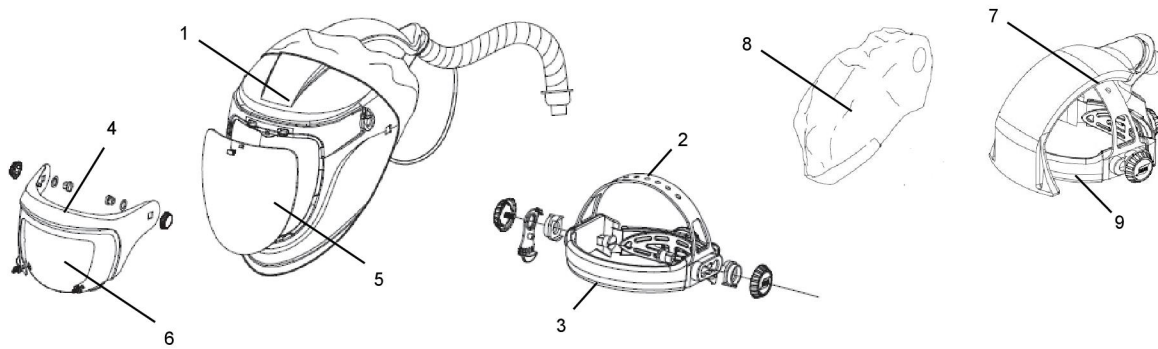

Item	Ordering no.	Denomination	Notes
	0700 000 430	G30 DIN 10, complete	
	0700 000 431	G30 DIN 11, complete	
	0700 000 433	G30 Air DIN 10, complete	
	0700 000 434	G30 Air DIN 11, complete	
1	0700 000 515	Main shell	G30, G40 and G50
2	0700 000 415	Headgear	
3	0700 000 414	Sweatband	
4	0700 000 508	Flip up frame	G30, Including screws
5	0700 000 501	Large inner visor	Clear, G30, G40 and G50
5	0700 000 502	Large inner visor	G30 DIN 2
5	0700 000 503	Large inner visor	G30 DIN 3
5	0700 000 504	Large inner visor	G30 DIN 5
6	0700 000 505	Outer flip visor	G30 DIN 5
6	0700 000 506	Outer flip visor	G30 DIN 8
6	0700 000 507	Outer flip visor	G30 DIN 10
7	0700 000 420	Headgear including air duct	
8	0700 000 512	Head and face seal	G30, G40 and G50
9	0700 000 274	Sweatband for air	

G40, G50, G40 Air and G50 Air

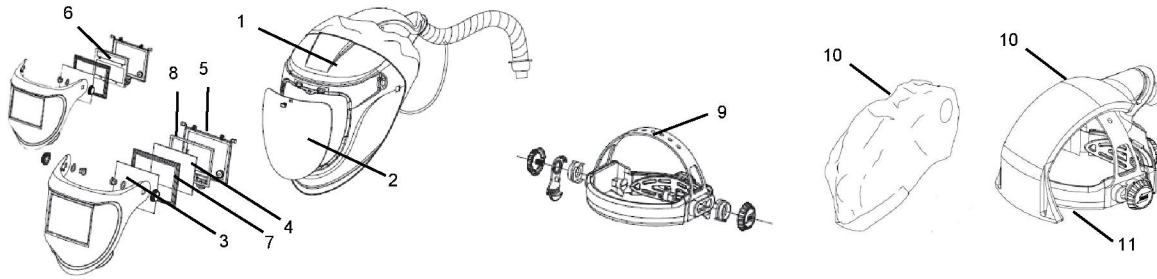

Item	Ordering no.	Denomination	Notes
	0700 000 436	G40, complete	60 × 110 mm
	0700 000 437	G40, complete	90 × 110 mm
	0700 000 438	G50 9-13, complete	
	0700 000 439	G40 Air, complete	60 × 110 mm
	0700 000 440	G40 Air, complete	90 × 110 mm
	0700 000 441	G50 Air 9-13, complete	
1	0700 000 515	Main shell	G30, G40 and G50
2	0700 000 501	Large inner visor	Clear, G30, G40 and G50
3	0700 000 517	Front cover lens	G40 and G50
4	0160 292 003	Mineral glass	G40 60 × 110 mm
4	0760 031 633	Mineral glass	G40 90 × 110 mm
5	0700 000 518	Lens retainer	G40 and G50
6	0700 000 523	ADF	G50
7	0700 000 519	Cradle	G40 90 × 110 mm and G50
7	0700 000 520	Cradle	G40 60 × 110 mm
8	0700 000 521	Gasket for mineral glass	G40 60 × 110 mm and 90 × 110 mm
9	0700 000 415	Headgear	
10	0700 000 420	Headgear including air duct	
11	0700 000 951	Head and face seal	G30, G40 and G50
	0700 000 274	Sweatband for air	



A WORLD OF PRODUCTS AND SOLUTIONS.



For contact information visit esab.com

ESAB AB, Lindholmsallén 9, Box 8004, 402 77 Gothenburg, Sweden, Phone +46 (0) 31 50 90 00

<http://manuals.esab.com>

